

An Info-gap Framework for Comparing Epistemic Uncertainty Models in Hybrid Structural Reliability Analysis

Antoine Ajenjo
Emmanuel Ardillon
Vincent Chabridon

EDF R&D, 6 Quai Watier, 78401 Chatou, France

Scott Cogan
Emeline Sadoulet-Reboul

Femto-ST Institute, Department of Applied Mechanics, 24 rue de l'épitauphe, 25000 Besançon, France

ANTOINE.AJENJO@EDF.FR
 EMMANUEL.ARDILLON@EDF.FR
 VINCENT.CHABRIDON@EDF.FR

SCOTT.COCHAN@UNIV-FCOMTE.FR
 EMELINE.SADOULET-REBOUL@UNIV-FCOMTE.FR

Abstract

The main objective of this work is to study the effect of the choice of the input uncertainty model on robustness evaluations of probabilities of failure. Aleatory and epistemic uncertainty are jointly propagated by considering hybrid models and applying random set theory. The notion of horizon of uncertainty found in the info-gap theory, which is usually used to assess the robustness of a model to uncertainty, allows the bounds on the failure probability obtained from different epistemic uncertainty models to be compared at increasing levels of uncertainty. Info-gap robustness and opportuneness curves are obtained and compared considering the interval model, triangular and trapezoidal possibility distributions, the probabilistic uniform distribution and the parallelepiped convex model on two toy cases. A specific demand value, as introduced in the info-gap theory, is used as a value of information metric to quantify the gain of information on the probability of failure between a less informative uncertainty model and a more informative one.

Keywords: hybrid structural reliability; epistemic uncertainty; robustness; info-gap; random sets

1. Introduction

In this paper, robust reliability analyses are conducted. Structural reliability [14] is of main interest in particular for risk-sensitive industries as power generation [2] for which evaluating the performance, and therefore the safety, is subject to uncertainty. Two types of uncertainty are commonly distinguished, namely aleatory and epistemic [13]. Aleatory uncertainty is associated to natural randomness and has been widely treated using the probabilistic framework. Epistemic uncertainty is seen as ignorance due to a lack of knowledge and is therefore potentially reducible. Several representations that are less informative than probability theory exist to treat such uncertainty. Beer et al. [5] and Zio and Pedroni [23] propose reviews of such methods. In many applications, both types of uncertainty coexist

which transforms standard reliability analysis (aleatory uncertainty only) to hybrid reliability analysis. Such context implies the need of a common framework to estimate hybrid reliability quantities of interest such as bounds on a probability of failure. The notion of robustness has many interpretations and mathematical representations [11]. In this paper, it is applied to hybrid reliability analysis and is seen as the capacity of the estimation of a reliability quantity of interest to be guaranteed to be acceptable despite the presence of epistemic uncertainty. A robustness analysis depends on how the uncertainty is modeled which leads to the following question: to what extent does the choice of the epistemic uncertainty representation affect a robustness analysis? In the context of hybrid reliability analysis, a methodology is proposed to assess, using an info-gap analysis [7], the robustness of the reliability estimation regarding the choice of the epistemic uncertainty representation in input. To do so, several epistemic uncertainty models are considered through the common framework provided by random set (RS) theory. This methodology enables to compare info-gap metrics (i.e., the so-called robustness and opportuneness curves) obtained from different uncertainty representations. The paper is organized as follows: Section 2 reminds to the readers the formulation of a standard reliability problem before introducing hybrid reliability analysis with the use of RS theory and ends with the main aspects of an info-gap analysis, Section 3 describes the framework that is used and how info-gap and RS theory are combined to provide a comparison methodology, finally Section 4 shows the results of the methodology applied on two toy-cases.

2. Background Material

2.1. Structural Reliability Analysis (SRA)

The objective of a structural reliability analysis is to assess the performance of a system subject to uncertainty. The performance $z \in \mathbb{R}$ (supposed to be scalar here, for the sake

of simplicity) is evaluated through an analytical or numerical model $\mathcal{M}(\mathbf{x})$ where $\mathbf{x} \in \mathbb{R}^d$ with d the number of input variables on which the system's performance depends such as geometrical quantities, material properties, or loads. One common practise in SRA is to check that the performance of the model does not take a higher (or lower, depending on the safety criterion) value than a given threshold z_{th} which is represented in the limit-state function g :

$$g(\mathbf{x}) = z_{\text{th}} - \mathcal{M}(\mathbf{x}). \quad (1)$$

The limit-state function separates the input domain $D_{\mathbf{X}}$ into the failure domain \mathcal{F} and the safety domain \mathcal{S} :

$$\mathcal{F} = \{\mathbf{x} \in D_{\mathbf{X}}, g(\mathbf{x}) \leq 0\} \quad (2a)$$

$$\mathcal{S} = \{\mathbf{x} \in D_{\mathbf{X}}, g(\mathbf{x}) > 0\}. \quad (2b)$$

The probabilistic theory offers a framework to treat uncertainty when information about natural randomness of the input vector is available. The input vector is considered as a realization of the random vector $\mathbf{X} = (X_1, X_2, \dots, X_{n_X})^\top$ to which a supposedly known joint probability density function (pdf) $f_{\mathbf{X}}$ is attributed. After propagating the uncertainty through the computer model $\mathcal{M}(\cdot)$, the performance z is also a realization of the output random variable Z . The exact pdf f_Z is generally inaccessible but several quantities of interest can be estimated such as moments or quantiles. Often in reliability analysis, and therefore in this work, the failure probability P_f is of interest:

$$P_f = Pr[g(\mathbf{X}) \leq 0] = \int_{\mathcal{F}} f_{\mathbf{X}}(\mathbf{x}) d\mathbf{x}. \quad (3)$$

Generally in structural reliability assessments, failure probabilities are low, computer models may be time consuming and crude Monte Carlo evaluations are not tractable. Consequently, advanced techniques are needed to evaluate Equation (3) such as sampling methods (Subset Simulation, Importance Sampling) or approximation methods (first- and second-order reliability methods, a.k.a. FORM/SORM). In this work, the Importance Sampling method [15] based on the FORM design point is mainly used.

2.2. Hybrid Reliability Analysis Using Random Set Theory

The probabilistic framework is a very powerful and detailed way to model and propagate aleatory uncertainty. Nevertheless, the exact knowledge of $f_{\mathbf{X}}$ requires the knowledge of the pdf of each component X_i and the dependence structure (i.e., the copula) between components which is often not achieved especially when poor data is available. Epistemic uncertainty characterizes the lack of information as it is potentially reducible by gathering more knowledge. As mentioned in introduction, many types of epistemic models can be found in the literature depending on the nature of the uncertainty and the available information. Here, the

main properties of the uncertainty representations investigated in this paper, namely interval model, convex model, evidence theory, possibility distributions and probability box (p-box) theory, are reminded. In order to stay coherent with the rest of the paper, the variables that are modeled by such representations are described by the vector $\mathbf{Y} = (Y_1, Y_2, \dots, Y_{n_Y})^\top$.

- *Interval model*: The interval representation only uses bounds to model the uncertainty on an input quantity Y_i . Therefore, the only hypothesis made here is that Y_i belongs to $I_{Y_i} = [Y_i^L, Y_i^U]$. When each Y_i is represented as an interval, the input space becomes the n_Y -box represented by the Cartesian product $I_Y = \times_{i=1}^{n_Y} I_{Y_i}$ where n_Y is the number of interval variables. After propagation through the numerical model \mathcal{M} , the performance is also an interval with no additional information. The bounds $[Z^L, Z^U]$ may be estimated using an optimization algorithm or the vertex method which states that the extreme values of the performance are obtained for combinations of the extreme values of Y_i . Methods to treat hybrid reliability problems involving both random and interval variables can be found in [10, 12].
- *Convex model*: Convex models [8] are also a non-probabilistic representation of uncertainty which contains the interval model. It enables to add the information of possible dependencies between the input variables. The ellipsoid and the parallelogram models are common convex examples. When the input variables are independent, the convex model reduces to the n_Y -box which characterizes the interval representation. In the same way as for the interval model, the bounds on the performance function can be obtained using an optimization algorithm in the convex set. The multi-parallelepiped model [17] is used in this paper as it has the advantage of combining dependent and independent variables together and that a sample in this convex set can be obtained from a sample \mathbf{u} of the hypercube $U = [-1, 1]^{n_Y}$ with the following transformation:

$$Y_i = \frac{Y_i^W}{\sum_{j=1}^{n_Y} |\rho(i, j)|} \sum_{k=1}^{n_Y} \rho_{ik} u_k + X_i^C, \quad (4)$$

$$i = 1, 2, \dots, n_Y$$

where $Y_i^C = \frac{Y_i^U + Y_i^L}{2}$, $Y_i^W = X_i^U - X_i^C$ and ρ is the correlation matrix.

- *Evidence theory*: Evidence theory (also called Dempster-Shafer theory) [9, 19] assigns weights to subsets A , also called focal sets, of the power set $\Omega(Y)$ using the following mass distribution \mathbf{v} :

$$\mathbf{v} : | \Omega(Y) \rightarrow [0, 1]$$

$$A \rightarrow \mathbf{v}(A) \text{ s.t. } \sum_{A \in \Omega(Y)} \mathbf{v}(A) = 1. \quad (5)$$

It follows the definition of two measures namely the belief function $Bel(\cdot)$ and the plausibility function $Pl(\cdot)$ that bound the realization of any event E :

$$Bel(E) = \sum_{A \subseteq E} v(A) \quad (6a)$$

$$Pl(E) = \sum_{A \cap E \neq \emptyset} v(A). \quad (6b)$$

The belief measure can be seen as an upper probability of the event E while the plausibility measure can be seen as a lower probability. When combining evidence theory to a reliability analysis [22], the belief and plausibility measures enable to bound the probability of failure by considering the event $E = \{Y \in \mathcal{F}\}$. When the focal sets are singletons, the belief measure is equal to the plausibility measure and evidence theory reduces to probability theory. When there is only one focal set, it reduces to the interval representation.

- *Possibility theory*: Possibility theory is a special case of evidence theory where focal sets are nested and is defined with the following possibility distribution π :

$$\pi : \Omega(Y) \rightarrow [0, 1] \text{ s.t. } \sup_{y \in \Omega(Y)} \pi(y) = 1. \quad (7)$$

The triangular and trapezoidal distributions are common examples. It follows the definition of two measures, namely the possibility $\Pi(\cdot)$ and the necessity $N(\cdot)$:

$$\Pi(E) = \sup_{y \in A} \pi(y) \quad (8a)$$

$$N(E) = \inf_{y \notin A} (1 - \pi(y)). \quad (8b)$$

α -cuts are commonly associated to a possibility distribution as they may be seen as nested confidence intervals with the following expression:

$$[y_{-\alpha}, \bar{y}_{\alpha}] = \{y, \pi(y) \geq \alpha\}. \quad (9)$$

Baudrit and Dubois [4] propose a method to jointly propagate probabilistic and possibilistic information.

- *Probability boxes*: The probability box (p-box) theory assigns an imprecise cumulative distribution function (cdf) to the uncertain variable Y . The true yet uncertain cdf is bounded by an upper cdf \bar{F}_Y and a lower cdf \underline{F}_Y :

$$\bar{F}_Y(y) \leq F_Y(y) \leq \underline{F}_Y(y). \quad (10)$$

Two groups of p-boxes are distinguished, namely free p-boxes and parametric p-boxes. Free p-boxes do not make any more assumptions than the bounds on the true cdf. Any shape that respects the bounds and the properties of a cdf is possible. Parametric p-boxes

assume that the distribution type is known (e.g., Gaussian, uniform). The uncertainty lies in the parameters of the distribution (e.g., mean, variance) that are modeled using simple intervals. Therefore, at equal bounds, parametric p-boxes are more informative than free p-boxes by adding the information of the distribution type. Many uncertainty models already mentioned can be represented as free p-boxes. Indeed, by considering the event $Y \leq y$, plausibility and necessity measures can be seen as lower cdfs while belief and possibility measures can be seen as upper cdfs. Probability theory is retrieved when $\bar{F}_Y(y) = \underline{F}_Y(y)$. Schöbi and Sudret [18] compare results obtained from free and parametric p-boxes using surrogate models.

This work falls in the scope of hybrid reliability analysis, meaning that the input vector can be divided into two vectors, namely \mathbf{X} and \mathbf{Y} where \mathbf{X} is a random vector with a fully determined pdf $f_{\mathbf{X}}$ and \mathbf{Y} contains the input variables subject to epistemic uncertainty and described by one of the models mentioned previously. As one realization of the hybrid limit-state function $g(\mathbf{X}, \mathbf{Y})$ is a random set, one cannot compute a single probability of failure as in standard reliability analysis but only its bounds $[\underline{P}_f, \bar{P}_f]$:

$$\underline{P}_f = Pr[\bar{g}(\mathbf{X}, \mathbf{Y})] = Pr[\max g(\mathbf{X}, \mathbf{Y}) \leq 0] \quad (11a)$$

$$\bar{P}_f = Pr[g(\mathbf{X}, \mathbf{Y})] = Pr[\min g(\mathbf{X}, \mathbf{Y}) \leq 0]. \quad (11b)$$

In order to apply the existing failure probability estimation methods to the hybrid problem, a framework that enables the propagation of random variables with a mixture of different epistemic models is needed. Random set theory (denoted RS) makes it possible [1] as it generalizes probabilistic and epistemic models. A random set is very closely related to evidence theory and is defined by the function Γ :

$$\Gamma : \begin{cases} \Omega \rightarrow A \\ \alpha \rightarrow \Gamma(\alpha) \end{cases} \quad (12)$$

where A is the focal set and $\Gamma(\alpha)$ is a focal element. In other words, a random set is like a random variable whose realization is a set in A , not a number. The event E is bounded by an upper probability and a lower probability that are quite similar to Equations (6a) and (6b):

$$\underline{P}_{\Gamma}(E) = P_{\Omega}(\{\alpha \in \Omega : \Gamma(\alpha) \subseteq E, \Gamma(\alpha) \neq \emptyset\}) \quad (13a)$$

$$\bar{P}_{\Gamma}(E) = P_{\Omega}(\{\alpha \in \Omega : \Gamma(\alpha) \cap E \neq \emptyset\}) \quad (13b)$$

with $P_{\Gamma} := P_{\Omega} \circ \Gamma^{-1}$. This definition links RS with the different uncertainty representations mentioned before as presented in Table 1 which gives the corresponding RS for each uncertainty representation.

A RS can also be obtained from evidence theory by linking it to the p-box representation as follows:

$$\bar{F}_Y(y) = Pl(Y \leq y) \quad (14a)$$

Table 1: The expression of $\Gamma(\alpha)$ for each uncertainty representation.

Uncertainty model	$\Gamma(\alpha)$
Interval	I
Convex	$C(I, \rho)$
Possibility	$\{y \in Y : \pi(y) \geq \alpha\}$
Free p-box	$[\underline{F}_Y^{-1}(\alpha), \overline{F}_Y^{-1}(\alpha)]$
Probability	$F_Y^{-1}(\alpha)$

$$F_Y(y) = \text{Bel}(Y \leq y). \quad (14b)$$

The interval and convex models are special cases where the random set is actually a constant set as the function does not depend on α . The probability model is a special case where the random set is a singleton. A sample of the random set in higher dimension than one is obtained by sampling the vector α from a copula C and computing the Cartesian product $\times_{k=1}^{n_\alpha} \Gamma_k(\alpha_k)$ which is a n_α -box with $n_\alpha = n_X + n_Y$ being the number of input variables. The limit-state functions in Equations (11a) and (11b) can be rewritten as follows:

$$\bar{g}(\mathbf{X}, \mathbf{Y}) = \bar{g}(\alpha) = \max_{\Gamma_{XY}(\alpha)} g(\alpha) \quad (15a)$$

$$\underline{g}(\mathbf{X}, \mathbf{Y}) = \underline{g}(\alpha) = \min_{\Gamma_{XY}(\alpha)} g(\alpha) \quad (15b)$$

which yields for the bounds on P_f :

$$\bar{P}_f = \int_{\Omega} \mathbb{1}_{\underline{g}(\alpha) \leq 0} dC(\alpha) \quad (16a)$$

$$P_f = \int_{\Omega} \mathbb{1}_{\bar{g}(\alpha) \leq 0} dC(\alpha) \quad (16b)$$

where $\mathbb{1}_E$ is the indicator function that equals to one when the event E is valid or to zero when it is not. The hybrid reliability analysis problem is reduced to two standard reliability analyses on which standard estimation methods may be used.

2.3. Robustness Analysis

Robustness analysis is of main interest in engineering applications. A system is considered robust if small variations on an expected state of operation do not considerably deteriorate the expected performance. A robust solution may be preferable over a non-robust optimal solution [20]. The info-gap method aims at quantitatively measuring this notion of robustness in the context of decision making by introducing the following robustness function h_{IG}^* given by:

$$h_{IG}^* = \max_h \left\{ \max_{\mathbf{u} \in U(h, \tilde{\mathbf{u}})} R(\mathbf{q}, \mathbf{u}) \leq r_c \right\} \quad (17)$$

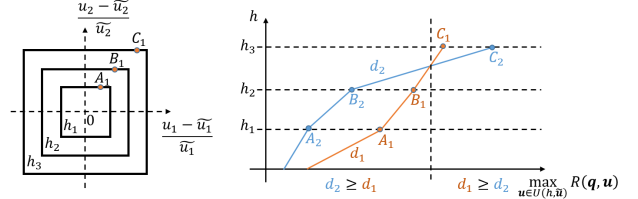

Figure 1: Nested convex sets (left) and associated robustness curves with preference reversal (right).

where h_{IG}^* is defined as the maximum amount of uncertainty that can be tolerated, i.e., for which the worst possible performance is still acceptable. Three components appear in an info-gap model and in Equation (17):

- the performance function $R(\mathbf{q}, \mathbf{u})$ that evaluates the quantity of interest of a system of characteristic vector \mathbf{q} at specific values of the uncertain vector \mathbf{u} ;
- the critical performance r_c which is the value that the quantity of interest must not exceed (to be distinguished with the threshold z_{th} introduced in Equation (1)). Its value may be determined or not in an IG analysis;
- the uncertainty model $U(h, \tilde{\mathbf{u}})$ which is a non-probabilistic generally convex set, as introduced in Section 2.2, of horizon of uncertainty h containing the best estimation $\tilde{\mathbf{u}}$ (nominal value of \mathbf{u}) of the uncertain vector \mathbf{u} . For $h = 0$, $U(h, \tilde{\mathbf{u}})$ reduces to $\tilde{\mathbf{u}}$.

A key feature of the convex uncertainty models is that they are nested as the example depicted in Figure 1:

$$U(h_1, \tilde{\mathbf{u}}) \subseteq U(h_2, \tilde{\mathbf{u}}) \text{ for } h_1 \leq h_2. \quad (18)$$

Therefore, the robustness function is monotonous with respect to the horizon of uncertainty. Uncertainty can also be beneficial as the real performance of the system may be better than the expected one. To illustrate this point, the opportuneness function β_{IG}^* is defined as:

$$\beta_{IG}^* = \min_h \left\{ \min_{\mathbf{u} \in U(h, \tilde{\mathbf{u}})} R(\mathbf{q}, \mathbf{u}) \leq r_w \right\} \quad (19)$$

where r_w can be seen as a reward threshold. The idea with the IG framework is to compare the robustness values of different possible decisions \mathbf{d} in order to keep the most robust one given a critical performance value. The most robust decision may depend on the choice of the critical performance value as seen in Figure 1 where both curves cross each others. The decision d_2 is more robust before

the curves intersect but the decision d_1 is more robust after. This is called the reversal of preference. Not many hypotheses are needed in an IG analysis as it can be conducted only with the choice of a non-probabilistic convex uncertainty model and the best guess of the uncertain vector \mathbf{u} . However, both hypotheses may have an influence on the robustness evaluation. The effect of the uncertainty model on the robustness curve can be seen as a value of information (VoI) analysis [6] where the aim is to quantify the gain in robustness when using a more informative uncertainty model than another. An IG uncertainty model U_1 is more informative than U_2 if the following set inclusion is obtained:

$$U_1(h, \tilde{\mathbf{u}}) \subset U_2(h, \tilde{\mathbf{u}}), \forall h \geq 0. \quad (20)$$

For a given critical performance r_c , U_1 will yield a higher robustness value. For a given horizon of uncertainty, the worst performance in U_1 will be better than the one in U_2 . These comparisons are expressed respectively as the robustness premium Δh^* and the demand value Δr_c .

3. Robust HRA

3.1. HRA Framework

The goal in this work is to analyse the effect of the choice of an epistemic uncertainty model on the robustness of a reliability quantity. Here, one considers the bounds of the failure probability obtained by hybrid reliability analysis as the two quantities of interest. As mentioned in Section 2, the limit-state function $g(\mathbf{X}, \mathbf{Y})$ depends on both vectors \mathbf{X} and \mathbf{Y} . The vector \mathbf{X} contains the input variables X_i that are modeled as random variables. The joint distribution $f_{\mathbf{X}}(\mathbf{x})$ is considered perfectly determined (no epistemic uncertainty). The vector \mathbf{Y} contains the input variables Y_i for which epistemic uncertainty does not allow a well defined deterministic or probabilistic modeling. As it was seen in Section 2, RS theory enables to model and propagate many different uncertainty models together (including probabilistic cumulative distribution functions). In order to compare the effect of each epistemic uncertainty model, the bounds on the probability of failure are estimated and compared for a same epistemic representation of each input variable Y_i . The different epistemic models for which results are shown in this paper are:

- interval model;
- parallelepiped convex model;
- possibility triangular distribution;
- possibility trapezoidal distribution.

Probabilistic uniform distributions on Y_i are also added to the comparison. Results obtained by considering the p-box

representation and evidence theory are not presented in order to respect the page limit. In order to estimate the bounds on the probability of failure, Equations (16a) and (16b) need to be evaluated. The inner loop which corresponds to the search of the minimum and maximum of the limit-state function for one realization of the random set $\Gamma(\alpha)$ is performed using an optimization algorithm. The outer loop corresponds to the estimation method of the probability of failure. As an inner optimization loop is involved, hybrid reliability analysis usually requires more evaluation of the limit-state function than with a standard reliability analysis. Moreover, the lower bound of the probability of failure to be estimated may be very small (e.g., such that $P_f < 10^{-5}$). Therefore, some estimation methods such as Monte Carlo sampling are not tractable. In this paper, the outer loop is performed with an Importance Sampling around the most probable failure point obtained with a FORM analysis [15]. However, note that several other advanced sampling methods could have been used here (e.g., subset sampling, line sampling) [16].

3.2. Comparison by means of Info-gap Robustness and Opportuneness Curves

As seen in Section 2.3, the info-gap framework quantifies the notions of robustness and opportunity to uncertainty by building nested convex sets around a nominal state which represents the analyst's best guess. When the performance of the model is characterized by its probability of failure, an info-gap analysis requires to perform several hybrid reliability analysis at increasing horizons of uncertainty where the epistemic uncertainty model is the interval or convex model (that can be applied directly on the input variable but also on parameters of a distribution function as for p-box representation). An interesting feature is that it enables to compare different possible decisions in view of choosing the one that maximizes the robustness given a critical performance. Info-gap analysis can also be used to assess the VoI. Indeed, the different decisions can be directly linked to the choice of different uncertainty models $U_i(h, \tilde{\mathbf{u}})$ that each has its own degree of information. Therefore, it is possible to compare robustness and opportuneness curves of different uncertainty models for \mathbf{Y} by considering the random set function as the IG uncertainty model as follows:

$$U_i(h, \tilde{\mathbf{Y}}) = \Gamma_i(\alpha) \quad (21)$$

with:

$$\begin{aligned} \Gamma_i : [0, 1]^{m_Y} &\rightarrow S_Y(h, \tilde{\mathbf{Y}}) \\ \alpha &\rightarrow \Gamma_i(\alpha) \end{aligned} \quad (22)$$

where $[0, 1]^{m_Y}$ is the unit hypercube and S_Y is the support of \mathbf{Y} that gets wider when the horizon of uncertainty h

increases:

$$S_Y(h, \tilde{\mathbf{Y}}) = \left\{ \mathbf{Y}, \tilde{\mathbf{Y}}(1-h) \leq \mathbf{Y} \leq \tilde{\mathbf{Y}}(1+h) \right\}, \quad (23)$$

$$h \geq 0.$$

Whatever the type of uncertainty model that is used for \mathbf{Y} , for a given h , the same support is used to compare bounds obtained from each model which enables a meaningful comparison. Moreover, the fact that bounds are calculated for increasing horizons of uncertainty and, therefore, growing supports, enables a comparison in terms of robustness and opportuneness functions. The larger the support, the more impact the choice of the uncertainty model has on the bounds of the probability of failure. The following quantity $R_{\bar{P}_f}^{(ij)}$ is defined in this paper as the demand value between a less informative uncertainty model U_i and a more informative uncertainty model U_j and is used as the VoI metric:

$$R_{\bar{P}_f}^{(ij)} = 1 - \frac{\bar{P}_f(\Gamma_i(h))}{\bar{P}_f(\Gamma_j(h))} \quad (24)$$

The value of this metric, which is negative as $\bar{P}_f(\Gamma_i(h)) \geq \bar{P}_f(\Gamma_j(h))$, shows how the added information from model U_i to model U_j diminishes, in terms of percentage, the upper bound of the failure probability. A similar metric could be defined with the lower bound to quantify how a more informative model reduces the best possible outcome. Such metric is not used in this paper as, generally in a reliability analysis, the concern of how the worst possible outcome may be reduced with more information is of higher interest.

3.3. Proposed Methodology

This part aims at summarizing the steps that are followed to apply the proposed methodology to two numerical reliability problems.

1. Separate the uncertain input variables into the random vector \mathbf{X} with fully determined joint cdf and the epistemic vector \mathbf{Y} with corresponding nominal values;
2. Define groups of gradually informative epistemic uncertainty representations of same finite support;
3. Compute the random set function of each uncertainty representation (e.g., inverse cdf, α -cuts, parallelepiped convex model);
4. Compute the two optimization problems for each limit-state function;
5. Build the same nested supports parametrized with a finite number of horizons of uncertainty $h_i \in [0, h_{\max}]$ on which each epistemic uncertainty model is defined;
6. Estimate, for each uncertainty representation and for each horizon of uncertainty, the bounds of the failure probability;
7. Plot the robustness and opportuneness curves for each uncertainty representation and plot the VoI metric $R_{\bar{P}_f}^{(ij)}$.

4. Numerical Applications

Two toy cases are used in order to apply the proposed methodology. The first one is purely mathematical while the second one corresponds to a cantilever beam problem. In both cases, the limit-state function $g(\mathbf{X}, \mathbf{Y})$ has an analytical expression and is therefore easy to compute and evaluate. The comparison of the uncertainty models applied to \mathbf{Y} is divided into two groups, namely G_1 and G_2 . G_1 compares the following uncertainty models: the interval model, the trapezoidal possibility distribution, the triangular possibility distribution and the probabilistic uniform distribution. G_2 compares the interval model with the parallelepiped convex model for different correlation coefficients ρ_{ij} . Robustness and opportuneness curves obtained with each epistemic uncertainty model and their corresponding 95% confidence interval are shown. A surface plot is also used for G_1 to show the values of $R_{\bar{P}_f}^{(ij)}$ from one model to another depending on the horizon of uncertainty. The methodology was numerically implemented on Python using mainly the Scipy package to solve the optimization problems induced by both hybrid limit-state functions and the OpenTURNS software [3] to estimate failure probabilities using Importance Sampling.

4.1. Toy Case 1

The first toy case is taken from Xiao et al. [21] and has the following limit-state function:

$$g(\mathbf{X}, Y) = Y + \sin\left(\frac{5(X_1 + 1.5)}{2}\right) - \frac{\left((X_1 + 1.5)^2 + 4\right)(X_2 + 1.5)}{20} \quad (25)$$

where X_1 and X_2 follow a standard Gaussian distribution and Y is the unique epistemic variable that has the nominal value $\tilde{Y} = 3.5$. The fact that the input dimension $n_\alpha = n_X + n_Y = 3$ enables to draw the iso-lines of both limit-state functions $\underline{g}(\alpha, h) = 0$ and $\bar{g}(\alpha, h) = 0$ in the α -space for different values of h and different uncertainty models. As Y is here one-dimensional, any convex model reduces to the simple interval model. Therefore, only the results for the G_1 group are presented. The robustness and opportuneness curves are obtained by discretizing h with 15 values in $[0, 0.5]$. Figure 2 and Figure 3 show the shapes

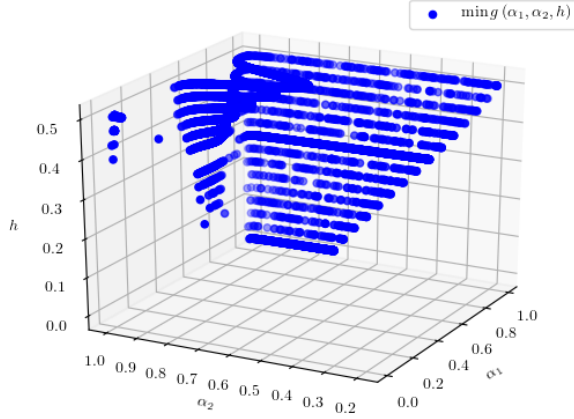

Figure 2: The iso-lines of $\underline{g}(\alpha_1, \alpha_2, h)$ with the interval model.

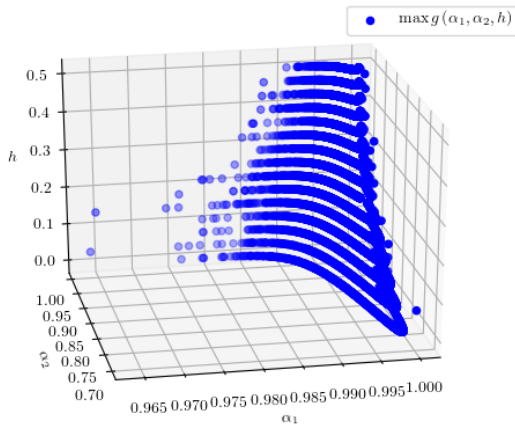

Figure 3: The iso-lines of $\bar{g}(\alpha_1, \alpha_2, h)$ with the interval model.

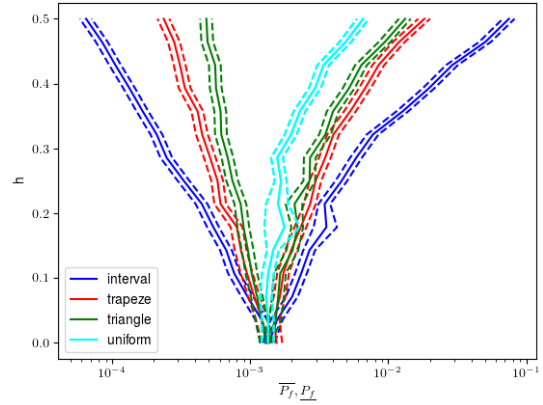

Figure 4: G_1 comparison of robustness and opportuneness curves for toy case 1.

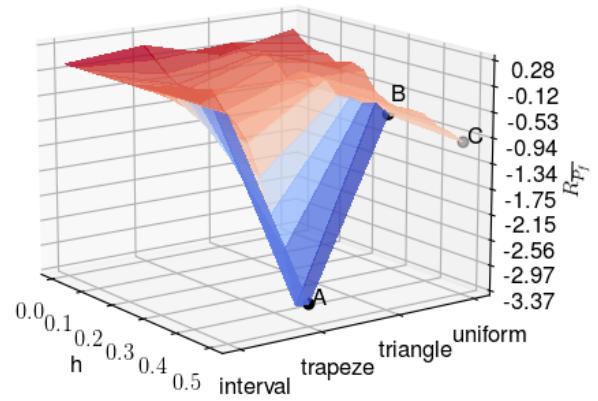

Figure 5: G_1 VoI comparison for toy case 1.

of $g(\alpha, h) = 0$ and $\bar{g}(\alpha, h) = 0$. Figure 4 shows the robustness and opportuneness curves for G_1 . As expected, the larger the horizon of uncertainty and therefore the support of Y the larger the interval on P_f for the three representations that are not purely probabilistic. One can see how the gain of information, first from the interval to the trapezoidal one, then to the triangular one, and finally to the uniform distribution, reduces the uncertainty on the quantity of interest. Figure 5 shows the VoI metric $R_{P_f}^{(ij)}$. The highest gain of robustness between two consecutive (in terms of information) uncertainty models is between the interval and trapezoidal models. Indeed, for $h = 0.5$, going from the interval model to the trapezoidal model (point A) leads to a decrease on \bar{P}_f of 309% while only 38% from the trapezoidal model to the triangular model (point B) and 102% from the triangular model to the uniform model (point C).

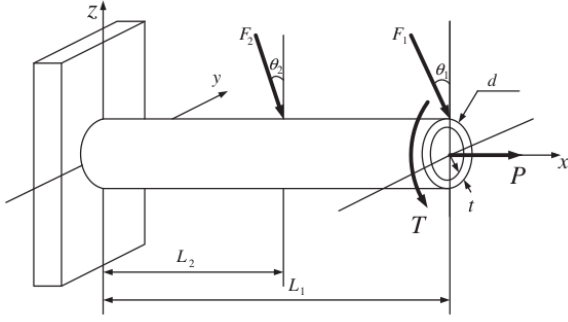

Figure 6: Cantilever beam.

4.2. Cantilever Beam

The second toy case [1] corresponds to the cantilever beam subjected to a torsional moment T , lateral forces F_1 and F_2 and an axial force P , as depicted in Figure 6. The limit-state function has the following expression:

$$g(\mathbf{X}, \mathbf{Y}) = \sigma_y - \sqrt{\sigma_x^2 + 3\tau_{xz}^2} \quad (26)$$

where $\sigma_x = \frac{P + F_1 \sin \theta_1 + F_2 \sin \theta_2}{A} + \frac{Md}{2I}$ is the normal stress and $\tau_{xz} = \frac{Td}{4I}$ is the shear stress with $A = \pi(d^2 - (d-2t)^2)/4$ the cross-sectional area and $I = \pi(d^4 - (d-2t)^4)/64$ the second moment of inertia. The random vector \mathbf{X} is $\mathbf{X} = [P(\text{kN}), t(\text{mm}), d(\text{mm}), L_1(\text{mm}), L_2(\text{mm})]$. The distribution of each independent random variable is given in Table 2. The epistemic vector \mathbf{Y} is $\mathbf{Y} =$

Table 2: Distributions of the random variables in toy case 2.

Variable	Distribution	Param. 1	Param. 2
P	Normal	12	1.2
t	Normal	5	0.1
d	Normal	42	0.5
L_1	Uniform	119	121
L_2	Uniform	59	60

$[F_1(\text{kN}), F_2(\text{kN}), \theta_1(\text{rad}), \theta_2(\text{rad}), T(\text{N.m})]$ with its nominal values $\tilde{\mathbf{Y}} = [3, 3, 0.175, 0.350, 90]$. The robustness and opportuneness curves are obtained by discretizing h with 10 values in $[0, 0.05]$. Figure 7 shows the robustness and opportuneness curves for group G_1 . Figure 8 shows the VoI surface plot for group G_1 . Once again, the choice of the uncertainty model has a significant impact on the interval obtained for P_f as soon as the horizon of uncertainty increases. Going from the interval model to the trapezoidal

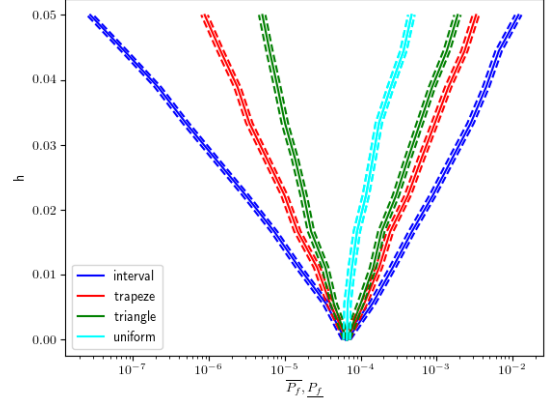

Figure 7: G_1 comparison of robustness and opportuneness curves for toy case 2.

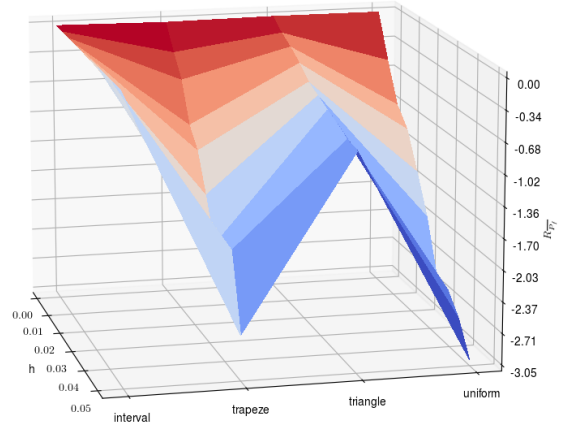

Figure 8: G_1 VoI comparison for toy case 2.

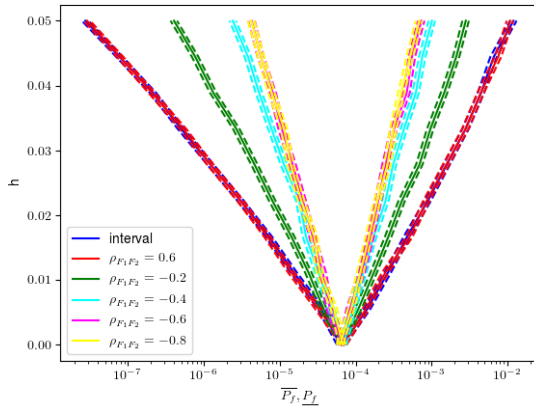

Figure 9: G_2 comparison of robustness and opportuneness curves for toy case 2.

model or from the triangle model to the uniform model considerably improves the robustness of the quantity of interest. Figure 9 shows the robustness and opportuneness curves for group G_2 by assigning a non-zero coefficient of correlation $\rho_{F_1 F_2}$ between the two lateral forces F_1 and F_2 . It appears that a positive coefficient of correlation gives similar results than the ones obtained with the interval model whereas a negative coefficient will reduce the interval on P_f . This can be explained by the fact that the extreme values of the limit-state function are obtained for both combinations of the highest values of F_1 and F_2 and the lowest values of F_1 and F_2 (bottom left and top right vertices of the parallelepiped).

5. Conclusion

In this paper, a methodology was proposed in order to analyse the robustness of different epistemic uncertainty representations in function of the information they each enable to model. In the context of hybrid reliability analysis, the random set framework is suitable to model and propagate different representations of uncertainty to estimate reliability quantities of interest such as bounds on a probability of failure. An info-gap robustness analysis was performed by considering each type of uncertainty model in an increasing support of the epistemic variables. This methodology enabled to compare robustness and opportuneness curves between uncertainty models that are more or less informative on two toy cases. As expected, the larger the support the more effect the choice of the uncertainty model has on the bounds of the probability of failure and therefore on the robustness analysis. The objective is obviously not to determine the best representation of uncertainty as it mainly depends on the available information

but to give insight on how the uncertainty model can impact a robustness analysis. The methodology may also be applied considering Dempster-Shafer structures and probability box representation. An analogous work is currently performed on an industrial case relevant to the French electric company EDF and concerns the reliability assessment of penstocks. A hybrid reliability analysis requires a high computational effort when no specific hypotheses are made as it demands a very large number of evaluations of the initial limit-state function. A research perspective would be to analyse and to compare the computational effort when using different uncertainty models in a robustness analysis. Such comparison would depend on many factors and especially on hypotheses that can be made (e.g., monotony of the limit-state function with respect to the epistemic variables) and the numerous strategies that have already been developed to reduce this computational burden (e.g., combination of surrogate models with smart optimization algorithms).

References

- [1] D.A. Alvarez, F. Uribe, and J.E. Hurtado. Estimation of the lower and upper bounds on the probability of failure using subset simulation and random set theory. *Mechanical Systems and Signal Processing*, 100:782–801, 2018.
- [2] E. Ardillon, D. Proske, A. Chateauneuf, and A. Lannoy. SRA into SRA: Structural reliability analyses into system risk assessment. *The ESReDA collective book*, 2010.
- [3] M. Baudin, A. Dutfoy, B. Iooss, and Anne-Laure Popelin. OpenTURNS: An industrial software for uncertainty quantification in simulation. In R. Ghanem, D. Higdon, and H. Owahdi, editors, *Handbook of Uncertainty Quantification*, pages 2001–2038. Springer, 2017.
- [4] C. Baudrit and D. Dubois. Joint propagation and exploitation of probabilistic and possibilistic information in risk assessment. *IEEE Transactions on Fuzzy Systems*, 14:593–608, 2006.
- [5] M. Beer, S. Ferson, and V. Kreinovich. Imprecise probabilities in engineering analyses. *Mechanical Systems and Signal Processing*, 37:4–29, 2013.
- [6] Y. Ben-Haïm. Info-gap value of information in model updating. *Mechanical Systems and Signal Processing*, 15(3):457–474, 2001.
- [7] Y. Ben-Haïm. *Info-Gap Decision Theory: Decisions under Severe Uncertainty*. Elsevier, 2006.

- [8] Y. Ben-Haïm and I. Elishakoff. *Convex models of uncertainty in applied mechanics*. Elsevier, 1990.
- [9] A.P. Dempster. Upper and lower probabilities induced by a multivalued mapping. *The Annals of Mathematical Statistics*, 38(2):325–339, 1967.
- [10] X. Du, A. Sudjianto, and B. Huang. Reliability-based design under the mixture of random and interval variables. *Journal of Mechanical Design*, 127(6):1068–1076, 2005.
- [11] S.M. Göhler, T. Eifler, and T.J. Howard. Robustness Metrics: Consolidating the multiple approaches to quantify Robustness. *Journal of Mechanical Design*, 138(11):111407, 2016.
- [12] C. Jiang, G.Y. Lu, and L.X. Liu. A new reliability analysis method for uncertain structures with random and interval variables. *International Journal of Mechanics and Materials in Design*, 8:169–182, 2012.
- [13] A. Der Kiureghian. Aleatory or epistemic? does it matter? *Structural Safety*, 31(2):105–112, 2009.
- [14] M. Lemaire. *Structural Reliability*. Wiley & Sons, 2009.
- [15] R.E. Melchers. Importance sampling in structural systems. *Structural Safety*, 6:3–10, 1989.
- [16] J. Morio and M. Balesdent. *Estimation of rare event probabilities in complex aerospace and other systems: a practical approach*. Elsevier, 2015.
- [17] B.Y. Ni, C. Jiang, and X. Han. An improved multidimensional parallelepiped non-probabilistic model for structural uncertainty analysis. *Applied Mathematical Modelling*, 40:4727–4745, 2016.
- [18] R. Schöbi and B. Sudret. Structural reliability analysis for p-boxes using multi-level meta-models. *Probabilistic Engineering Mechanics*, 48:27–38, 2017.
- [19] G. Shafer. *A mathematical theory of evidence*. NJ: Princeton, 1976.
- [20] I. Takewaki and I. Ben-Haïm. Info-gap robust design with load and model uncertainties. *Journal of Sound and Vibrations*, 288:551–570, 2005.
- [21] M. Xiao, J. Zhang, L. Gao, S. Lee, and A.T. Eshghi. An efficient Kriging-based subest simulation method for hybrid reliability analysis under random and interval variables with small failure probability. *Structural and Multidisciplinary Optimization*, 59(6):2077–2092, 2019.
- [22] Z. Zhang, C. Jiang, X. Han, D. Hu, and S. Yu. A response surface approach for structural reliability analysis using evidence theory. *Advances in Engineering Software*, 69:37–45, 2014.
- [23] E. Zio and N. Pedroni. Literature review of methods for representing uncertainty. *Cahiers de la Sécurité Industrielle, Technical Report, Foundation for an Industrial Safety Culture*, 2013.